



Dimensions 48x48x80 mm (1/16 DIN)

#### Main features

- **Operator interface with large LCD Display, customizable, with choice of colors**
- **Scrolling diagnostics messages, configurable, in the selected language**
- **Easy, guided configuration, copy/paste parameters even with power off**
- **Preventive maintenance with energy counters (kWh) and load switching**
- **16 function block applications**
- **Timer, setpoint and algorithm programmer for controlling motorized valves**
- **Advanced tuning of control parameters**
- **Different password levels**
- **Universal input configurable for thermocouples, resistance thermometers, linear inputs**
- **Remote setpoint input**
- **Relay, logic, isolated analog outputs**
- **Up to two CT inputs for interrupted load diagnostics**
- **RS485 serial communication in Modbus RTU**
- **Removable faceplate for immediate replacement**
- **Sampling time 60ms**

#### PROFILE

##### Operator interface

Large LCD display with customization of colors assigned to PV and SV display, of color of plastic faceplate, and of logo. Scrolling alphanumeric display of 25 messages (32 letters each), completely configurable and savable, in three languages. Thanks to language selection and clear scrolling messages for diagnostics, alarms, and process state, the controller speaks the user's language.

##### Easy Configuration

Guided configuration for manual-free programming, with a few essential parameters and on-line help messages. Ability to clone configuration among controllers, even with power off and in the field, thanks to a mini portable configurator with Zapper battery. Extended configuration, creation of work recipes, and firmware updates via PC and GF\_eXpress software, even without powering the controllers. Thanks to the Smart Configurator function, you obtain the required parameter recipe by answering a few simple questions. Local configuration and operation with only four keys assigned to LEDs that serve as feedback for the pressed key and as guide to specify appropriate steps.

The initial parameters can always be reset, both from the keypad and from the GF\_eXpress Software tool.

##### Diagnostics, Preventive Maintenance, and Energy Monitor

Complete diagnostics for broken or incorrectly connected probe, total or partial load break, out of range variables, and control loop faults.

Thanks to the switching count and to the settable alarm thresholds, you can program preventive maintenance to replace worn actuators.

An internal energy counter with alarm for abnormal variations totalizes energy consumptions and costs for constant control

##### Function block applications

Sixteen AND, OR, Timer Function Blocks let you create customizable logic sequences for complete and flexible machine control.

The controller's hardware resources are exploited completely, without any need for external devices such as timers and small PLCs

##### Tuning

Advanced tuning algorithms ensure stable and accurate control even with critical or very rapid thermal systems, engaging automatically when necessary.

##### Timer

Three types of timers let you set delay times before activating the control, hold times on the setpoint value, and timed changes of programmed setpoints.

##### Setpoint Programmer

Models with twelve ramp and hold steps, groupable in four programs, with enable inputs and event outputs, are available for applications with setpoint profiles. On-board configuration and graphic configuration with GF\_eXpress.

##### Valve Positioner

Models to control motorized valves, without feedback. Valve position is calculated and shown on the display.

##### General characteristics

The controller is completely software configurable without accessing the internal electronics.

The universal main input accepts thermocouple sensors, resistance thermometers, and linears.

The controller can be replaced at any time simply by removing the faceplate, without any additional procedures.

## DISPLAY AND KEYS

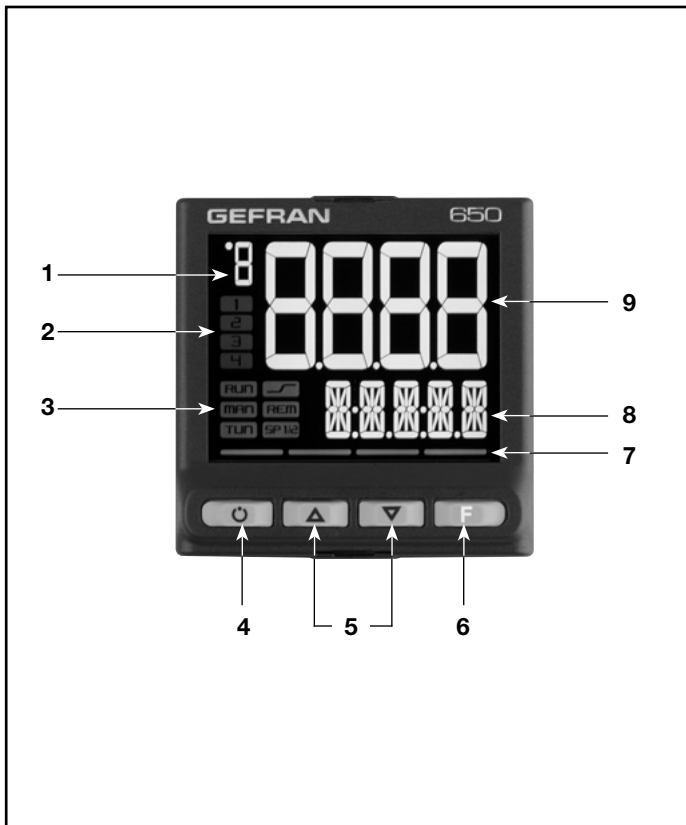

1. Temperature unit of measurement or number of program running.
2. State of outputs OUT1, OU2, OUT3, OUT4.
3. Controller function states:
  - RUN = setpoint programmer active;
  - \_/- = setpoint ramp active;
  - TUN = PID parameters tuning active;
  - MAN = manual/automatic (off = automatic control, on = manual control);
  - REM = remote setpoint enabled;
  - SP1/2 = setpoint active (off = setpoint 1, on = setpoint 2).
4. Work mode key (manual/automatic) in standard mode. A function can be assigned via parameter but1. The key is active only when the display shows the process variable
5. Up/down keys: raise/lower the value of the parameter displayed on the SV or PV display.
6. F key: lets you navigate among controller menus and parameters. Confirms the parameter value and selects the next parameter.
7. Key pressed signals.
8. SV display: setpoint value, description of parameters, diagnostics and alarm messages. Configurable with parameter dS.SP (default = setpoint).
9. PV display: process variable, parameter values.

## DIMENSIONS AND DRILLING TEMPLATE

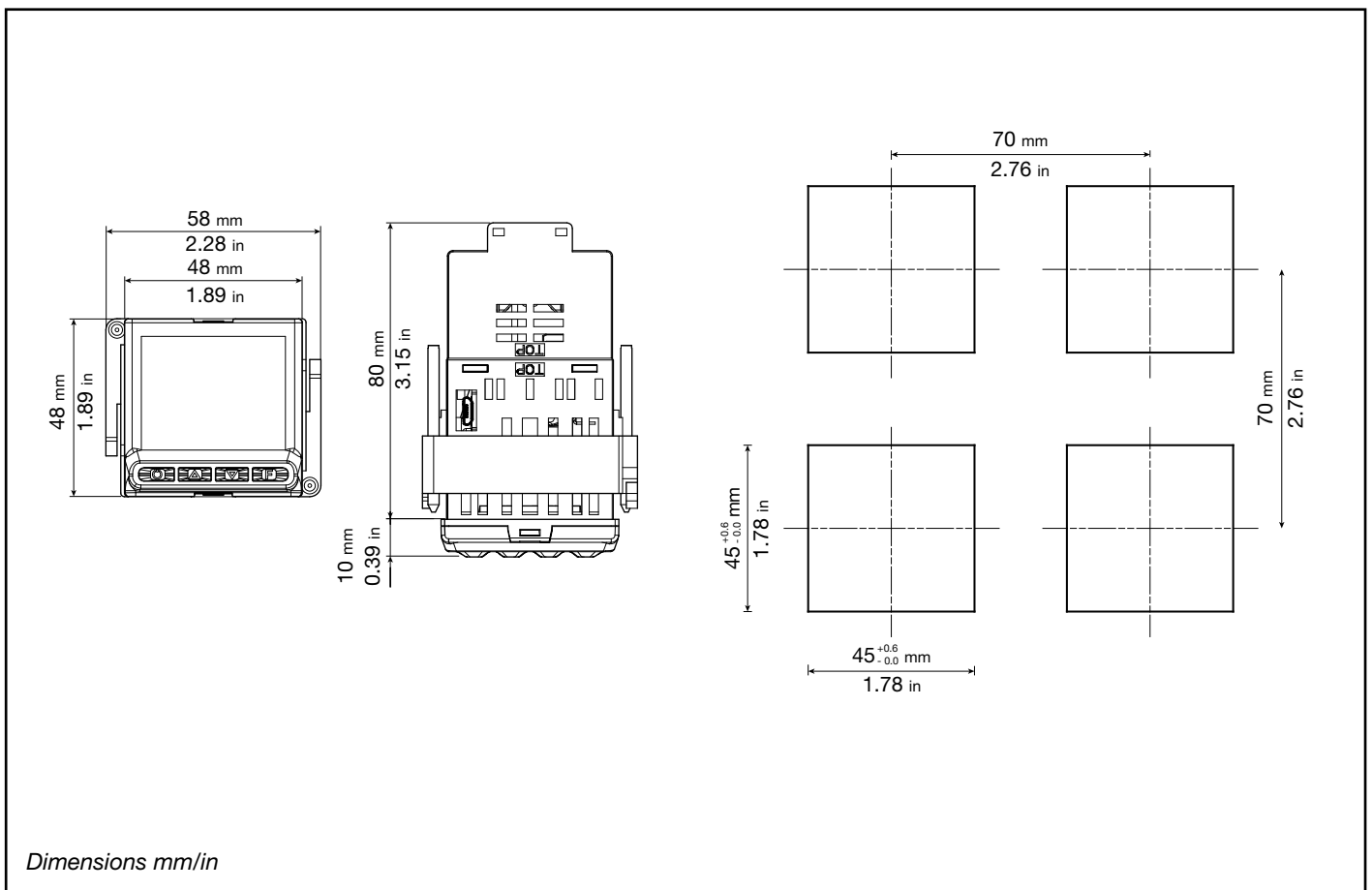

## TECHNICAL DATA

### OPERATOR INTERFACE

<b>DISPLAY</b>	Type	LCD black background
	Screen area (L x H)	35 × 30 mm
	Lighting	Backlit with LEDs, life > 40,000 hours @ 25°C
	PV display	Number of digits: 4 to 7 segments, with decimal point Digit height: 17 mm Color: white or “custom”
	SV display	Number of digits: 5 to 14 segments, with decimal point Digit height: 7.5 mm Color: green or “custom”
	Unit of measurement	Selectable, °C, °F or custom 1 Color: same as PV display
	Controller state signals	Number: 6 (RUN, MAN, _/-, REM, SP1/2) Color: amber
	Output state signals	Number: 4 (1, 2, 3, 4) Color: red
<b>KEYPAD</b>		Number of keys: 4 silicon (Man/Auto, INC, DEC, F) Type: mechanical

### INPUTS

<b>MAIN INPUT</b>	Sensor type	TC, RTD (PT100, JPT100), DC linear sensor	
	Accuracy	<b>TC inputs:</b> Calibration accuracy: < +/- (0,25% of reading value in °C +0,1°C) Linearization accuracy: 0,1% of reading value Cold junction accuracy: < +/- 1,5°C a 25°C room temperature) Cold junction compensation: > 30:1 rejection to the change of the room temperature <b>RTD input:</b> Calibration accuracy: < +/- (0,15% of reading value in °C +1°C) Temperature drift: < +/- (0,005% of reading value in °C +0,015°C)/°C from 25°C room temperature Linearization accuracy: 0,1% of reading value <b>Linear inputs:</b> Calibration accuracy: < 0,1% full scale Temperature drift: < +/- 0,005% full scale /°C at 25°C room temperature	
	Sampling time	60 ms / 120 ms, selectable	
	Digital filter	0,0...20,0 s	
	Temperature unit of measurement	Degrees C / F, selectable from keypad	
	Signal interval	Type: linear Scale: -1999...9999, settable decimal point	
	TC (thermocouple) input	Thermocouple: J, K, R, S, T, C, D Linearization: ITS90 or custom	
	RTD (resistance thermometer) input	Resistance thermometer: PT100, JPT100 Input impedance (Ri): ≥ 30 kΩ Linearization: DIN 43760 or custom Max. line resistance: 20 Ω	
DC linear input	0...60 mV	input impedance (Ri): > 70 kΩ	
	0...1 V	input impedance (Ri): > 15 kΩ	
	0...5 V / 0...10 V	input impedance (Ri): > 30 kΩ	
	0/4...20 mA	input impedance (Ri): 50 Ω	
	Linearization: linear or custom		
<b>AUXILIARY INPUT</b>	Remote setpoint	0...1 V, 0...10 V, 0/4...20 mA	
	Scale	0...1 V	input impedance (Ri): > 15 kΩ
		0...10 V	input impedance (Ri): > 30 kΩ
		0/4...20 mA	input impedance (Ri): 50 Ω
	Accuracy	0,1% f.s. ±1 digit @25 °C	
<b>CT (ammeter) INPUT</b>	Type	Isolated via external transformer	
		Number: 2 max Max. capacity: x / 50 mA AC Line frequency: 50/60 Hz Input impedance (Ri): 10 Ω	
	Accuracy	±2% f.s. ±1 digit @25 °C	

1) Programming is done with the GF\_eXpress configuration program.

<b>DIGITAL INPUTS</b>	Type	voltage-free contact, or NPN 24 V - 4,5 mA, or PNP 12/24 V - max 3,6 mA <i>(for detail see electrical connections)</i>
	Isolation	500 V
	Number	3 max
<b>OUTPUTS</b>		
	Relay (R)	Number: 4 max Type of relay contact: NO Max. current: 5 A, 250 VAC Minimum load: 5 V, 10 mA Life cycle: > 100.000 operations Double isolation
	Logic (D)	Number: 2 max Type: for solid-state relays Voltage: 24 V $\pm$ 10% (min 10 V @20 mA) Isolated from main input
	Triac ( long life relè) (T)	Number: 1 max Load: resistive Voltage: 75...264 VAC Current max: 1 A Isolation 3 kV snubber circuit integrated zero crossing switching
	Continuous (C)	Number: 1 max Current: 4...20mA $R_{out} < 500 \Omega$ Resolution: 12 bit Isolated from main input
	Analog retransmission (A1)	Number: 1 max 0...10 V, max 20 mA, $R_{out} > 500 \Omega$ 0...20 mA, 4...20 mA, $R_{out} < 500 \Omega$ Resolution: 12 bit Isolated from main input
<b>ALARMS</b>	Number of alarm functions	4 max, assignable to an output
	Possible configurations	Maximum, minimum, symmetric, absolute/relative, exclusion at firing, memory, reset from keypad and/or contact, LBA, HB HBB Hold Back Band if enabled with Programmer function
<b>CONTROL FUNCTIONS</b>		
<b>CONTROL</b>	Type	Single loop
	Control	PID, ON/OFF, single action heat or cool, double action heat/cool
	Control output	Continuous or ON/OFF Cycle time: constant or optimized (BF)
	Control output for motorized valves	OPEN/CLOSE for floating motorized valve on Relay, Solid-state, Triac outputs
<b>SETPOINT PROGRAMMER</b>	Number of programs	Max 4 Start / Stop / Reset / Skip via digital inputs and/or outputs from logic operations Output state: Run /Hold / Ready / End
	Number of steps	Max 12, each with own setpoint, ramp time and hold time Times settable in HH:MM or MM:SS Max 4 consents, configurable for ramp and for hold Max 4 events, configurable in ramp and in hold
<b>MULTIPLE SETPOINTS</b>	Number of setpoints	Max 4, selectable from digital input Each setpoint change is subject to set ramp, different for up and down ramp
<b>LOGIC <sup>1</sup> OPERATIONS</b>	Function blocks	Max 16, with 4 input variables per block. The result can act on the state of the controller, of the programmer on alarms and outputs. Each function contains an incorporated timer block timer.
<b>TIMER FUNCTION</b>	Modes	START / STOP STABILIZATION (timer is on when PV enters a band set around setpoint; at end of count you can activate an output, shut down SW or change SP1/SP2) FIRING (timed activation of control after power on)

1) Programming is done with the GF\_eXpress configuration program.

<b>ENERGY COUNTER</b>		Calculation done on nominal line voltage and nominal load power or on rms current measured on load via CT
<b>DIAGNOSTIC</b>		Short circuit or open circuit (LBA alarm) Interrupted or partially interrupted load (HB alarm) Short circuit of control output (SSR alarm)
<b>RETENTIVE MEMORY</b>	Type	EEPROM
	Max. number of writes	1.000.000
<b>SERIAL INTERFACE</b>		
	Type	RS485
	Baudrate	1200, 2400, 4800, 9600, 19.200, 38.400, 57.600, 115.200 bit/s
	Protocoll	MODBUS RTU
		Isolated from main input
<b>GENERAL DATA</b>		
<b>POWER SUPPLY</b>	Operating voltage	100...240 VAC/VDC $\pm 10\%$ , 50/60 Hz (on request 20...27 VAC/VDC $\pm 10\%$ )
	Power dissipation	5 W max
	Protections	Overvoltage 300 V / 35 V
	Connection	Screw terminals and crimp connector, max. wire section 1 mm <sup>2</sup>
<b>CONNECTIONS</b>	Serial configuration port (for USB connection)	Connector: microUSB
	Inputs and outputs	Screw terminals and crimp connector, max. wire section 2,5 mm <sup>2</sup>
<b>AMBIENT CONDITIONS</b>	Use	Indoor
	Altitude	2,000 m max
	Operating temperature	-10 ... +55 °C (as per IEC 68-2-14)
	Storage temperature	-20 ... +70 °C (as per IEC 68-2-14)
	Relative humidity	20...85% RH non-condensing (as per IEC 68-2-3)
<b>PROTECTION LEVEL</b>		IP 65 on front panel (as per IEC 68-2-3)
<b>ASSEMBLY</b>	Positioning	On panel, removable faceplate
	Installation regulations	Installation category: II; Pollution degree: 2 Isolation: double
<b>DIMENSIONS</b>		48 X 48 mm (1/16 DIN), Depth: 80 mm
<b>WEIGHT</b>		0,16 kg
<b>CE STANDARDS</b>	EMC (electromagnetic compatibility)	Conforms to Directiv 2014/30/EU with reference to standard EN 61326-1 emission in industrial environment class A for models 650 LV emission in residential environment class B for models 650 HV
	Safety: LVD	Conforms to Directiv 2014/35/EU with reference to standard EN61010-1

## ACCESSORIES

Code	Description
<b>F060800</b>	Cable for programming with PC, USB-TTL 3 V with USB – microUSB connectors, length 1.8 m
<b>F043958</b>	“GF_eXpress” software CD
<b>F060909</b>	Configuration kit for new instruments GF_eXK-3-0-0
<b>F060908</b>	Portable configurator, complete with cable and Zapper
<b>51968</b>	Rubber gasket 48x48 front-box
<b>51250</b>	Fastening box to panel
<b>51294</b>	Protection of contacts at box bottom
<b>51454</b>	18 contacts at box bottom
<b>330200</b>	Current transformer (CT) 50/0.05 A
<b>330201</b>	Current transformer (CT) 25/0.05 A

# CONNECTION DIAGRAM

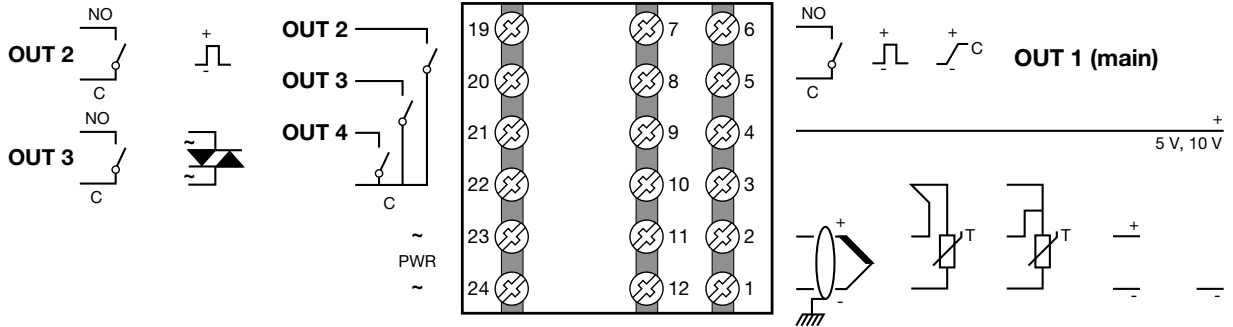

## OPTIONS

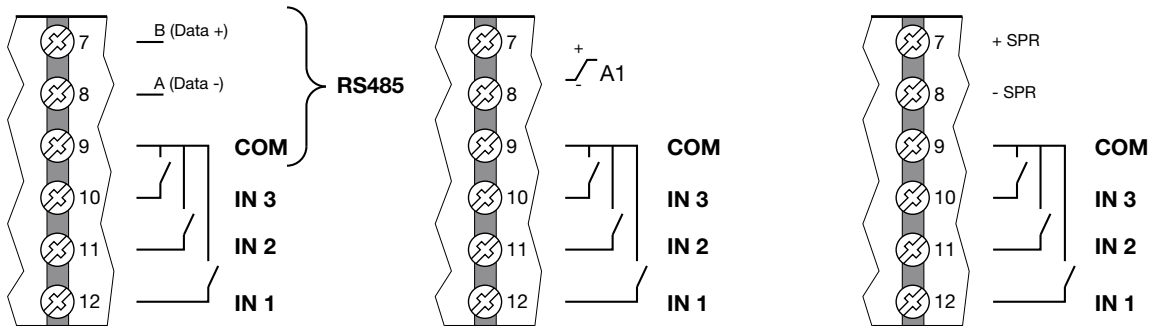
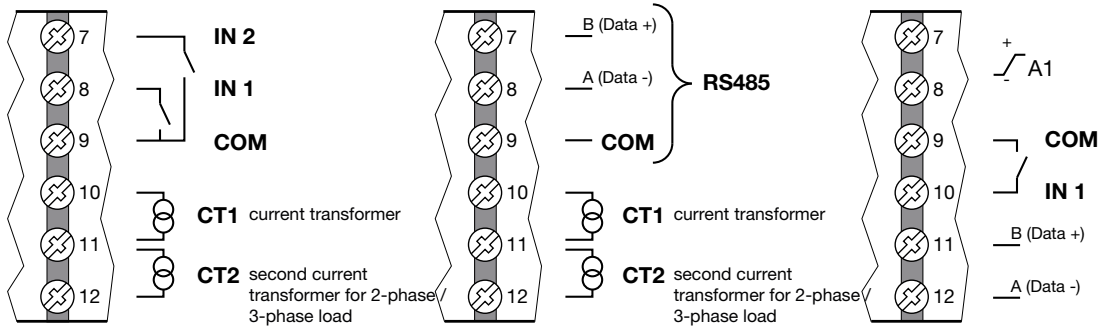

## LEGEND

- Power supply
- Linear input in voltage / current
- Input for current transformer
- Remote Set-point

- Isolated digital inputs
- Thermocouple input
- Input PT100 JPT100 2 / 3 wires

- Relay output
- Long-life solid state relay output
- DC analog output
- Isolated analog output

- Logic output
- RS485 serial line



**ATTENTION:** For correct installation, read the warnings in the instruction manual.

## ORDER METHODS

Ordering code **650** X-X-X X X-X X X X X-X X X

Model	
Controller	-
Programmer	P
Valve	V

Output 1	
Relay	R
Static	D
Analog 4...20mA	C

Output 2 - 3 - 4	
1 Relay (5A)	R-0-0
1 Static	D-0-0
2 Relay (5A)	R-R-0
1 Static + 1 relay	D-R-0
1 Relay (5A) + 1 Long Life relay	R-T-0
1 Static + 1 Long Life relay	D-T-0
3 Relay (5A total)	R-R-R

Remote Set Point - W retransmission - CT inputs - Digital inputs - Serial communication	
Absent	0-0-0-0-0
CT1	0-0-1-0-0
CT1 + CT2	0-0-2-0-0
CT1 + 2 DI	0-0-1-2-0
CT1 + CT2+2 DI	0-0-2-2-0
CT1 + RS485	0-0-1-0-1
CT1 + CT2+RS485	0-0-2-0-1
3 DI	0-0-0-3-0
3 DI + RS485	0-0-0-3-1
3 DI + SPR	1-0-0-3-0
3 DI + W 0/4...20mA/0...10V	0-1-0-3-0
1 DI + W + RS485	0-1-0-1-1

Supply	
20-27Vac/dc	0
100-240Vac	1

Functions	
Logical operations	LF

Display	
Green setpoint	G

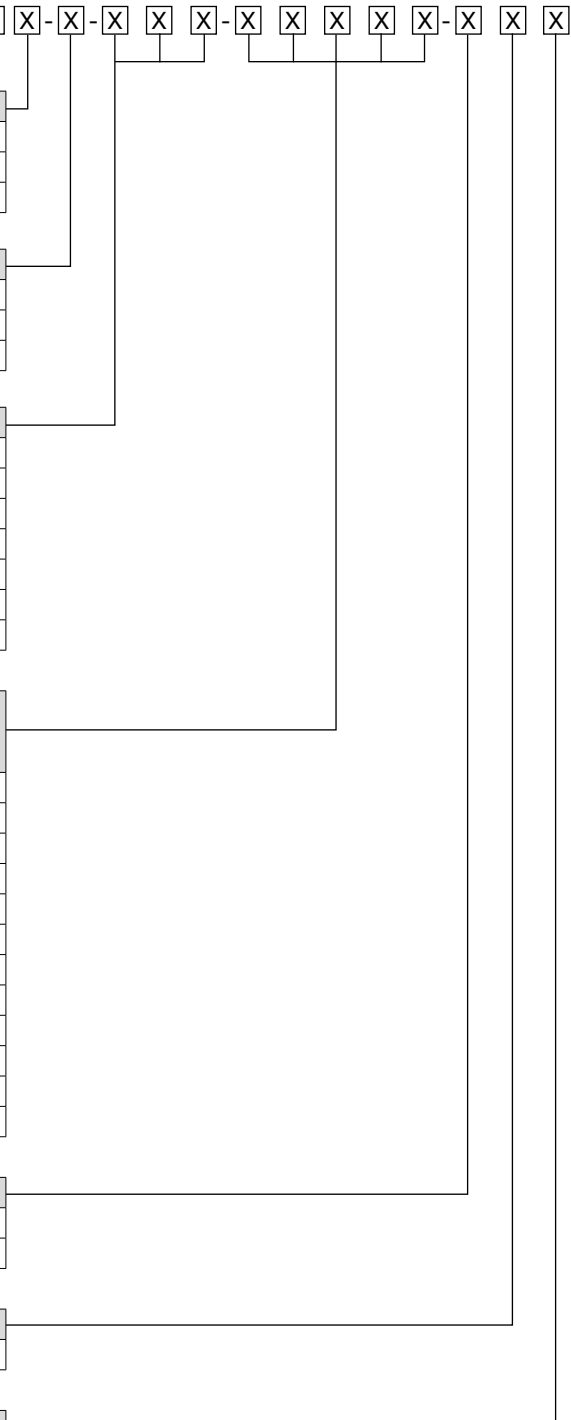

**Power supply 100...240 VAC**



Code F	Model	Valves	Programmer	Inputs			Outputs					RS485	Logic functions	Total Number of Outputs	
				Digital	CT	SPR	Relay	Triac	Logic	Analog I	Analog V/I				
F060558	650-D-R00-00000-1-G						1		1						2 outputs
F059574	650-R-R00-00000-1-G						2								
F060566	650-D-R00-00120-1-G			2	1		1		1						3 outputs
F060562	650-D-RR0-00000-1-G						2		1						
F065788	650-R-RR0-00000-1-G						3								
F065789	650-R-RT0-00000-1-G						2	1							
F065790	650-D-RR0-00030-1-G			3			2		1						
F060567	650-D-RR0-00200-1-G				2		2		1						
F060564	650-C-RR0-00000-1-G						2			1					
F060573	650-D-R00-01030-1-G			3			1		1		1				
F065791	650-R-R00-01030-1-G			3			2				1				
F060574	650-R-RR0-00101-1-G				1		3					•			
F060563	650-D-RRR-00000-1-G						3		1						4 outputs
F065792	650-R-RRR-00000-1-G						4								
F060575	650-D-RRR-00220-1LFG			2	2		3		1				•		
F060576	650-D-RRR-00031-1LFG			3			3		1				•	•	
F065793	650-D-RRR-00201-1LFG				2		3		1				•	•	
F065794	650-D-RR0-01011-1LFG			1			2		1		1		•	•	
F060577	650-C-RRR-10030-1LFG			3		1	3			1				•	
F060578	650V-R-RRR-00000-1-G	•					4								
F060561	650V-R-RRR-00030-1-G	•		3			4								
F060565	650P-D-RRR-00000-1-G		•				3		1						
F060560	650P-D-RRR-00030-1LFG		•	3			3		1					•	
F060579	650-D-RRR-01030-1LFG			3			3		1		1			•	5 outputs

**Power supply 20...27 VAC/VDC**

Code F	Model	Valves	Programmer	Inputs			Outputs					RS485	Logic functions	Total Number of Outputs	
				Digital	CT	SPR	Relay	Triac	Logic	Analog I	Analog V/I				
F065795	650-D-R00-00000-0-G						1		1						2 outputs
F065796	650-R-R00-00000-0-G						2								
F065797	650-D-R00-00120-0-G			2	1		1		1						3 outputs
F065798	650-D-RR0-00000-0-G						2		1						
F065799	650-R-RR0-00000-0-G						3								
F065800	650-R-RT0-00000-0-G						2	1							
F065801	650-D-RR0-00030-0-G			3			2		1						
F065802	650-D-RR0-00200-0-G				2		2		1						
F065803	650-C-RR0-00000-0-G						2			1					
F065804	650-D-R00-01030-0-G			3			1		1		1				
F065805	650-R-R00-01030-0-G			3			2				1				
F065806	650-R-RR0-00101-0-G				1		3					•			
F065807	650-D-RRR-00000-0-G						3		1						4 outputs
F065808	650-R-RRR-00000-0-G						4								
F065809	650-D-RRR-00220-0LFG			2	2		3		1				•	•	
F065810	650-D-RRR-00031-0LFG			3			3		1				•	•	
F065811	650-D-RRR-00201-0LFG				2		3		1				•	•	
F065812	650-D-RR0-01011-0LFG			1			2		1		1		•	•	
F065813	650-C-RRR-10030-0LFG			3		1	3			1				•	
F065818	650V-R-RRR-00000-0-G	•					4								
F065819	650V-R-RRR-00030-0-G	•		3			4								
F065820	650P-D-RRR-00000-0-G		•				3		1						
F065821	650P-D-RRR-00030-0LFG		•	3			3		1					•	
F065822	650-D-RRR-01030-0LFG			3			3		1		1			•	5 outputs

Please contact GEFRA for information on available codes.



	Conformity TC N° РУД-IT.АЛ32.б.01762
	Conformity C/UL/US File no. E216851
	EMC (electromagnetic compatibility): conforms to directive 2014/30/EU with reference to standard EN 61326-1 emission in industrial environment class A for models 650 LV emission in residential environment class B for models 650 HV Safety LVD: conforms to directive 2014/35/EU with reference to standard EN61010-1